



RUSH

WALL TOP ASSEMBLIES EXT'D 15MM

PRODUCT CODE: RU067 MB

FINISH: MATTE BLACK

- ✓ 3/4 TURN OPERATION
- ✓ CERAMIC DISC CARTRIDGE
- ✓ PREMIUM FINISHES
- ✓ PHOENIX WARRANTY

MATCH WITH...



TECHNICAL SPECIFICATIONS

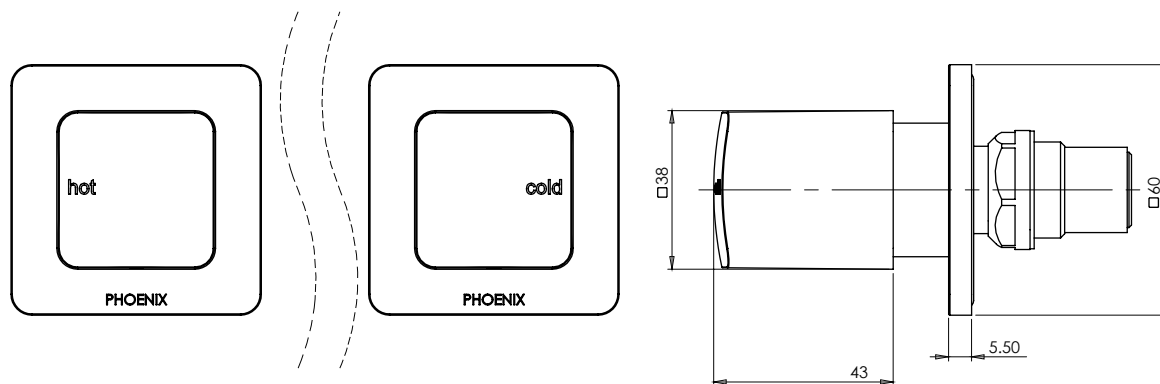

CONSUMER INFORMATION

RANGE:	RUSH
PRODUCT:	WALL TOP ASSEMBLIES EXT'D 15MM
PRODUCT CODE:	RJ067 MB
WATERMARK LICENCE:	WM21009
REVISION DATE:	NOVEMBER 2013
CONNECTION TYPE:	N/A
MATERIAL:	BRASS
AVAILABLE FINISHES:	CHROME, MATTE BLACK
WELS RATING:	N/A
FLOW RATE:	N/A
TEMPERATURE RATING:	MIN 1° - MAX 75°
PRESSURE RATING:	MIN 150 KPA - MAX 500 KPA

WARRANTY:	7 YEAR REPLACEMENT PRODUCT OR PARTS 1 YEAR REPLACEMENT PARTS OR PRODUCT & LABOUR
-----------	---

MERCHANT INFORMATION

CARTON SIZE:	L 140MM x W 130MM x H 62MM
CARTON WEIGHT:	1.25 KG
OUTER BOX SIZE:	L 300MM x W 280MM x H 320MM
OUTER BOX WEIGHT:	25 KG
OUTER BOX QUANTITY:	20 CARTONS
BARCODE NUMBER:	9320594 014 049

EXPLODED VIEW

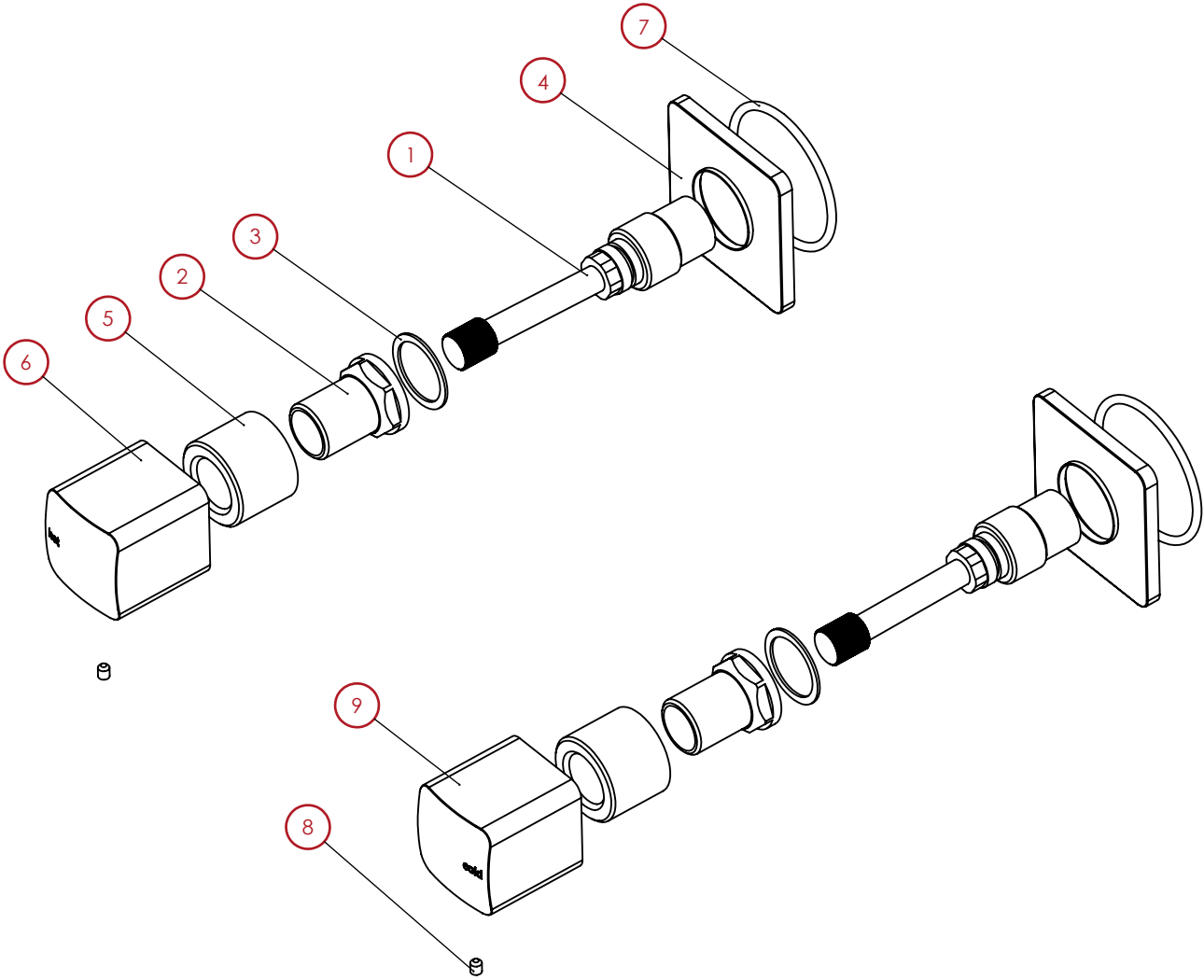

PARTS LIST

- 1. CERAMIC DISC CARTRIDGE 98MM
- 2. 48MM BONNET
- 3. FIBRE WASHER
- 4. WALL PLATE
- 5. HANDLE FLANGE
- 6. HOT HANDLE
- 7. O-RING
- 8. GRUB SCREW M4X5
- 9. COLD HANDLE

INSTALLATION INSTRUCTIONS

RUSH WALL TOP ASSEMBLIES

- 1** Check seats in Recess Breech (10) are in good condition and are free of foreign objects.

Recommended installation range for Recess Breech as shown in diagram.

Reseat if required.

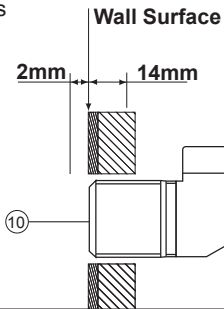

- 2** Screw Spindle (5) into Recess (10) till Spindle Seal with seat in Recess.
Do not over tighten
Fit Fibre Washer (6) around the Spindle. (5)

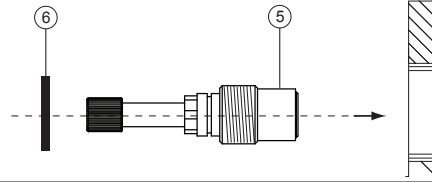

- 3** Fit Sealing Locknut (7) onto the Spindle (5) and tighten firmly using a spanner.

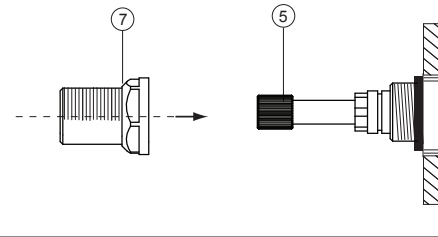

- 7** Installation completed.

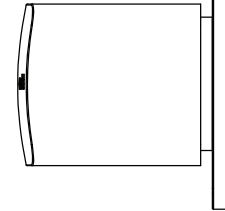

- 4** Fit O-Ring (9) to Dress Plate groove (3).
Fit Dress Plate (3) over Spindle (5).
Fasten Flange (4) to secure Dress Plate (3).

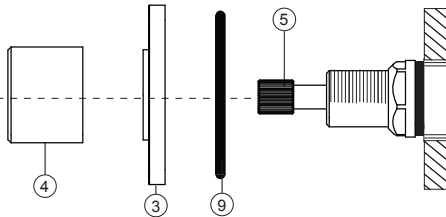

- 5** Fit Tap Handle (1) onto the Spindle (5) and fasten Grub Screw (2) With Allen Key (8).

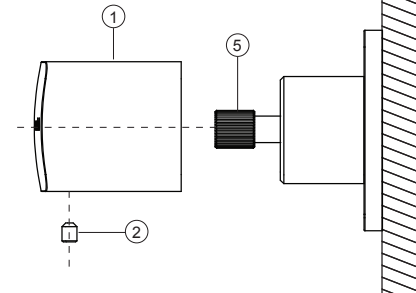

PART LIST

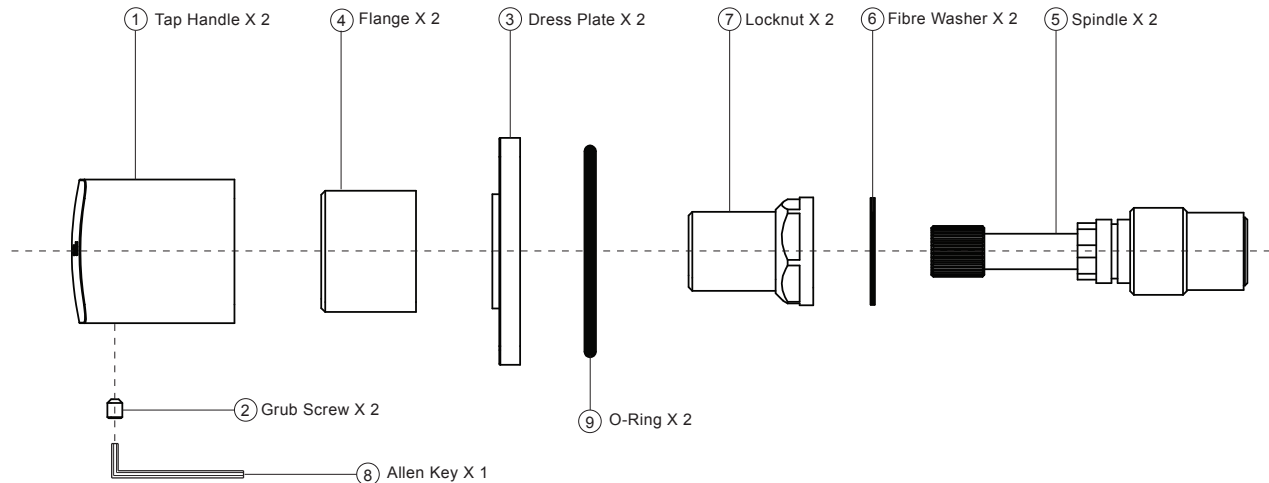

WATER SUPPLY REQUIREMENTS

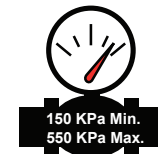

150 KPa Min.
550 KPa Max.
Recommended Working Pressure

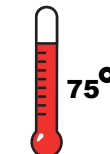

75°
Maximum hot water temperature

Note:

- If the pressure exceeds or is likely to exceed 550kpa, an approved pressure limiting device must be installed.
- Flush out all pipe work prior to installation.
- If the water temperature exceeds 75°C, an approved tempering valve must be fitted.
- Installation should comply with Australian standard AS3500.1 or relevant local authority requirements.

Failure to comply with the above may void all warranties.

Maintenance and Care

- Chrome plated surfaces should be cleaned with mild liquid detergent or soap and water.
- Do not** use cream cleaners or citrus based cleaning products, as they are abrasive.
- Use of unsuitable cleaning agents may damage the surface. Any damage caused in this way will not be covered by warranty.

NOTE : The handle with hot marking must be on the left hand side as viewed from the users position.

WARRANTY INFORMATION

MANUFACTURER'S WARRANTY

"Our goods come with a guarantee that cannot be excluded under the Australian Consumer Law ("ACL"), You are entitled to a replacement or refund for a major failure and for compensation for any reasonable or foreseeable loss or damage. You are also entitled to have repaired or replaced if the goods fail to be of acceptable quality and a failure does not amount to a major failure".

In addition to the above obligations Phoenix offers the following Manufacturer's Warranty subject to the following terms and conditions. Any provision in the warranty which is inconsistent with the ACL or is otherwise unenforceable shall be severed from this warranty to the extent of the inconsistency and the remainder of the provisions shall continue to apply.

WARRANTY PERIODS

Residential

Phoenix tapware and accessories is made to the highest industry standards and quality. Refer to table below for warranty periods.

Category	Warranty Period	Warranty Details
Mixers	15Years	-15 Years replacement cartridge -7Years replacement product or parts Note: Excludes damage to ceramic disc cartridges from pieces of copper tube, plastic tube, sand, dirt or thread tape etc. -1 Year replacement product or parts & labour.
Hand Shower on Rail	3Years	-3Years replacement product or parts -1 Year replacement product or parts and labour
Tapware & Standard Showers	7Years	-7Years replacement product or parts -1Year replacement product or parts and labour. Note: Jumper valves and ceramic disc spindles; 1Year parts only.
Accessories	7Years	-7Years replacement product or parts

* Note: These warranty periods apply to products purchased after 10th April 2011.

Commercial

(Hotels, Aged Care Facilities, Hospitals, Schools, Factories, Motels, etc.)

Category	Warranty Period	Warranty Details
All Products	1 Year	-1Year replacement product or parts

For all Service Enquiries contact below:

This Manufacturer's Warranty is provided by Phoenix Industries Pty Ltd.

Telephone: +61 3 9780 4200

Facsimile: + 61 3 9764 1898

Email: sales@phoenixtapware.com.au

Subject always to any overriding obligation pursuant to the ACL, warranty shall be void for the following reasons:

- Inability to provide proof of purchase or equivalent documentation.
- Products not installed by a licensed plumber.
- Products not to relevant National Standards and State Regulations.
- Products not installed in accordance with the manufacturer's installation instructions.
- Products exposed to environmental elements.
- Tapware exposed to water pressures and or temperatures that exceed stated limitations.
MAXIMUM: Temperature- 75 degrees & Pressure- 550kPa
MINIMUM: Temperature- 1 degree & Pressure - 150kPa (300kPa for Shower/Bath Diverters)
Note: AS/NSZ 3500.1-2003 (Clause 3.3.4) specifies 550kPa maximum water supply pressure at any outlet within a building for new installations.
- Showers may not be suitable for use within:
 - * Gravity-fed water systems.
 - * Some instantaneous hot water systems.
 - * Pressure supply less than 150kPa.
- Note: The 550kPa maximum water supply pressure does not apply to fire service outlets.
- Isolation stop taps are not fitted as stated on manufacturer's installation instructions.
- Fitting of other devices to the outlet of tapware, eg. water filters.

- Fitting of Phoenix non-approved water flow regulating devices.
- Fitting of other devices to outlet of tap, e.g., water filters.
- Non-installation of flow regulated check valve for hand showers.
- Products used for incorrect applications, non potable water etc.
- Damage as a result of obstructions due to inadequate flushing of system before use.
- Services repairs or with non-standard replacement parts previously undertaken without Phoenix's written approval.
- Damage to finishes by adhesives, sealants etc.
- Failure to clean & replace outlet aerator inserts etc.
- Damage to finishes which arise from installation or post installation use.
- Failure to observe manufacturers care and cleaning instructions.
- The warranty work is limited to the pre-approved scope of work. Additional work will require authorization from Phoenix After Sales & Services Departments.
- Evidence cannot be produced which confirms that the relevant product was purchased from a Phoenix Tapware authorized distributor.

WARRANTY CONDITIONS

Phoenix Warranty covers the repair or, at Phoenix's option, the replacement of any products which are defective through faulty workmanship or materials. The warranty period commences from date of purchase or for new buildings date of handover to a maximum period of 6 months. The warranty period for replacement products is limited to the expiry date of the original purchase. The warranty is limited to the original purchaser and non-transferable. In order to make a warranty claim, Proof of Purchase (POP), handover documentation for new homes or equivalent documentation must be supplied for warranty claims to be considered. Claims must be processed through Phoenix's Customer Service and each credit claim will be issued with a claim number which is recorded on the Phoenix system. Phoenix will not be liable for any claims for labour, additional products or parts associated with alleged faulty product for work not approved in advance by Phoenix in writing.

WARRANTY INFORMATION

WARRANTY CONDITIONS CONT.

Should any warranty claim be made and attended to by a Phoenix authorized Service Agent and that in the opinion of the Service Agent or Phoenix the problem was from faulty installation or use of the goods in conjunction with products of another manufacturer or from some other cause other than a manufacturing defect to the goods for which Phoenix is responsible, Phoenix has the right to charge a service fee for each service staff attending the Owner's premise where goods have been installed.

Phoenix requires adequate access to products, fittings and fixtures to undertake warranty repairs. Phoenix will not be responsible for any consequential damage or costs where adequate access to product fittings and fixtures is not accessible.

TAPWARE AND ACCESSORIES

Care and cleaning Instructions

- Under no circumstances should you install tapware using acetone silicones.
- Never use harsh detergents, citrus based cleaners or abrasive cleaners, as these will scratch the surface.
- Where your tapware remains dry in use, a soft cloth can be used to remove surface dust. Alternatively, a wipe over with warm soapy water is all that is required to maintain the finish in perfect condition for a lifetime of use.
- Use of wax based furniture cream should be avoided as these can result in a build-up of deposits, which could detract from the appearance.
- Do not use undue pressure and wipe in one direction only.

Note: Phoenix reserves the right to alter, or amend this warranty offer in writing at any time. Phoenix reserves the right to provide minor components (eg. handles, aerators, buttons, dress rings, hinges, clips, rod and washers) as 'Parts Only' to the customer.