

ASSEMBLE

aw™

A81.48.V3.H.V3

Installation Instructions

- Tapware to be installed by a licenced plumber in accordance with AS/NZS 3500:2003
- Recommended working water pressure 150 - 500kPa
- Maximum water temperature is 65 deg C
- After completing the installation check function of tapware and ensure no water leaks.

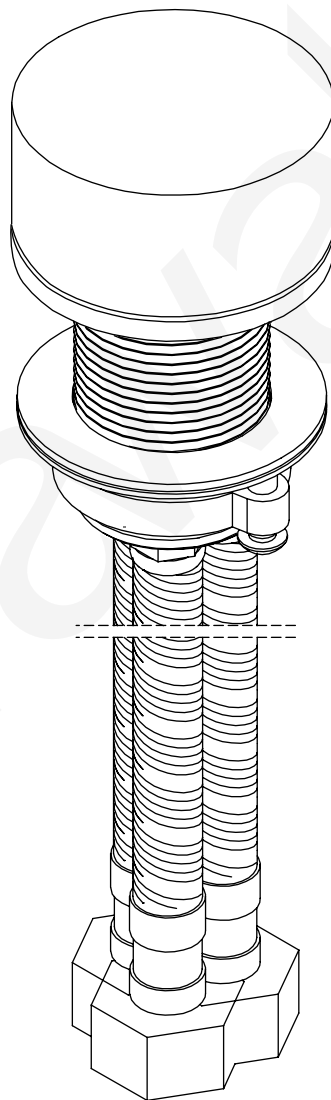

astrawalker™

ASSEMBLE



A81.48.V3.H.V3

Installation Instructions

Ensure water lines are completely flushed prior to connecting the new mixer.

Remove fixing nut and washers on assembled hob mixer.

Ensure that the flexible hoses are firmly connected into the base of the assembled mixer.

Place into position, and lower onto the mounting surface.

From the underneath secure washers and fixing nuts to the hob mixer

Connect the flexible hose outlet to the accompanying outlet.

Connect the hot and cold water supplies to isolating stop cocks.

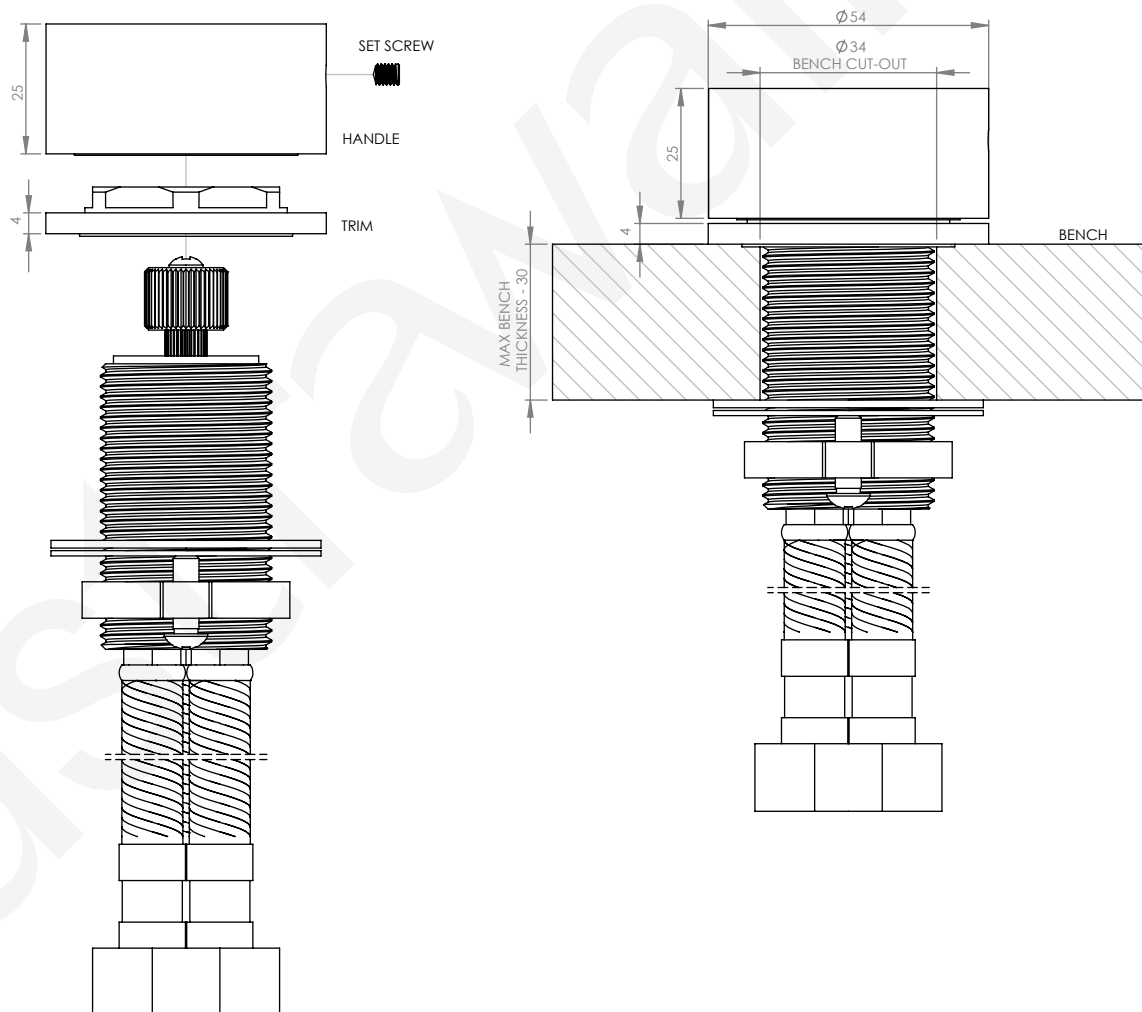

astrawalker™