

Radford

RAD-N-xx-NO

Note: All baths in Australia come standard **without** an overflow.
When installed with optional K50 waste kit, the overflow hole needs to be drilled on site by installer.



Bath shown with optional K50 waste kit



Classic double-ended bath

- Made from QUARRYCAST™
 - One piece casting of Volcanic Limestone™ and resin
 - Harder & more durable than acrylic
- Easy clean high gloss finish
- Exterior can be painted
- 25 year guarantee
- Available in six standard paint finishes, or explore our spectrum of new RAL colours in gloss or matt finishes



Zeitlose Viktorianische doppelseitige Familienwanne

- Hergestellt aus QUARRYCAST™
 - Ein Gussteil aus seltenem vulkanischen Kalkstein und Harz
 - Härter und haltbarer als Acryl
- Leicht zu reinigende glänzende Oberfläche
- Außenseite überstreichbar
- 25 Jahre Garantie
- Erhältlich in sechs Standardfarben sowie unserem neuen Spektrum an aktuellen RAL-Farben in Glanz oder matt



Baignoire classique à double assise

- Fabriquée en QUARRYCAST™
 - Ensemble d'une pièce en pierre volcanique rare et résine
 - Matériau plus dur et plus résistant que l'acrylique
- Fini ultra brillant, facile à nettoyer
- L'extérieur peut être peint
- Garantie de 25 ans
- Disponible en six finitions de peinture standard. Nous vous proposons également une palette de nouvelles couleurs RAL en finition brillante ou mate



Bañera clásica con doble espalda

- Hecho de QUARRYCAST™
 - Hecho en una pieza de piedra volcánica y resina
 - Más resistente y duradero que acrílico
- Fácil de limpiar y acabado brillante
- El exterior se puede pintar
- 25 años de garantía
- Disponible en seis acabados de pintura estándar. También puede consultar nuestra nueva gama de colores RAL en acabados brillo y mate



Vasca classica a doppio schienale

- Costituito da QUARRYCAST™
 - Un unico pezzo di rara roccia calcarea vulcanica e resina
 - Più robusto e resistente dell'acrilico
- Intensa finitura lucida facile da pulire
- L'esterno può essere verniciato
- 25 anni di garanzia
- Disponibile in sei finiture di verniciatura standard, oppure esplora il nostro spettro di nuovi colori RAL in finiture lucide o opache

25
years

Guaranteed for residential use for 25 years*
25 Jahre Garantie bei privater Nutzung
25 ans de garantie pour un usage domestique
Garantía de 25 años para uso domestico
La sicurezza garantita per uso residenziale per 25 anni

8
years

Guaranteed for commercial use for 8 years*
8 Jahre Garantie bei gewerblicher Nutzung
8 ans de garantie pour un usage commercial
Garantía de 8 años para uso comercial
La sicurezza garantita per uso commerciale per 8 anni

* QUARRYCAST™ white products only. Paint finish exterior guaranteed for 2 years.
* Nur auf weiße QUARRYCAST™ Produkte. Auf Aussenlackierung gibt es 2 Jahre Garantie.
* Uniquement pour les produits en QUARRYCAST™ blanc. Pour les finitions extérieures peintes la garantie est de 2 ans.
* Solo sobre productos en QUARRYCAST™ blanco. Acabados de pintura exterior tienen una garantía de 2 años.
* Solo per prodotti bianchi in QUARRYCAST™. Finitura esteriore dipinta garantita per due anni.

Radford

RAD-N-xx-NO

Special Options/Sonderoptionen/Options spéciales/Opciones especiales/Opzioni speciali



External finish

Use codes on right to determine SKU.

The colours shown here are not exact representations.

Verwenden Sie die Kodierung auf der rechten Seite um den SKU zu bestimmen. Die hier abgebildeten Farben sind möglicherweise nicht genau Darstellungen.

Utiliser le code à droite pour déterminer la référence produit. La couleur présentée n'est pas la nuance réelle.

Utiliza el código a la derecha para determinar el SKU. Los colores presentado aquí, pueden variar a la realidad.

Utilizza i codici sulla destra per determinare il prodotto. I colori mostrati non sono esattamente gli stessi.



RAD-N-SW-NO



RAD-N-MW-NO



RAD-N-BK-NO



RAD-N-GR-NO



RAD-N-MB-NO



RAD-N-AN-NO



RAD-N-SG-NO

SW QUARRYCAST™ White / QUARRYCAST™ weiß / QUARRYCAST™ blanc / QUARRYCAST™ blanco / QUARRYCAST™ bianco

MW Matt white / Weißer mattlack / Blanc mat / Blanco mate / Bianco opaco

BK Gloss black / Schwarzer Glanzlack / Noir brillant / Negro brillante / Nero lucido

GR Light grey / Hellgrau / Gris clair / Gris claro / Grigio chiaro

MB Matt black / Schwarzer Mattlack / Noir mat / Negro mate / Nero opaco

AN Anthracite / Anthrazit / Gris anthracite / Antracita / Anthracite

SG Stone grey / Steingrau / Gris pietra / Gris pierre / Grigio pietra

RAL colours



Also available in a spectrum of new RAL colours in gloss or matt finishes. For more information visit www.vandabaths.com.

Auch in einer Vielzahl neuer RAL-Farben in Glanz oder Matt erhältlich. Weitere Informationen unter www.vandabaths.com.

Egalement disponible dans toute une palette de nouvelles couleurs RAL pour les finitions brillantes ou mates. Pour davantage d'informations, rendez-vous sur www.vandabaths.com.

También disponible en una gama de colores RAL Nuevos, con acabados en brillo o mate. Para más información, visite www.vandabaths.com.

Disponibile inoltre in uno spettro di nuovi colori RAL, in finitura lucida o opaca. Per maggiori informazioni visita www.vandabaths.com.



Feet

Feet are supplied in the same colour as bath as standard.

Standard werden die Füße in der gleichen Farbe wie die Wanne geliefert.

Les pieds fournis seront de la même couleur que la baignoire.

Como estándar, los pies se suministran en el mismo color que la bañera.

I piedini sono forniti nello stesso colore della vasca.



FT-RAD-WH



FT-RAD-PC



FT-RAD-PB



FT-RAD-AB



FT-RAD-BN



FT-RAD-PN



FT-RAD-SW

WH White metal / Metall weiß / Métal blanc / de color blanco / metallo bianco

PC Polished chrome / Chrom poliert / Chromé / Cromado brillante / Cromo metallico lucidato

PB Polished Brass / Messing poliert / Doré / Latón pulido / ottone lucidato

BN Brushed nickel / Nickel gebürstet / Nickel mat / Níquel satinado / nickel spazzolato

PN Polished nickel / Nickel poliert / Nickel brillant / Níquel brillante / nickel lucidato

SW QUARRYCAST™ White / weiß / blanc / de color blanco / bianchi

AB Aged bronze / Bronze antik / Bronze Vieilli / Bronce envejecido / Bronzo invecchiato

Recommended: K12/K50

NOTE: Optional overflow hole needs to be drilled on site in Australia by installer



No overflow hole
Ohne Überlauf
Sans trou de trop-plein
Sin agujero rebosadero
Senza troppieno



Overflow hole
Mit Überlauf
Avec trou de trop-plein
Con agujero rebosadero
Troppieno



K12



K50

Related collections



Radford 51 basin

Radford

RAD-N-xx-NO

Note: Optional overflow hole needs to be drilled on site in Australia by installer

Top view

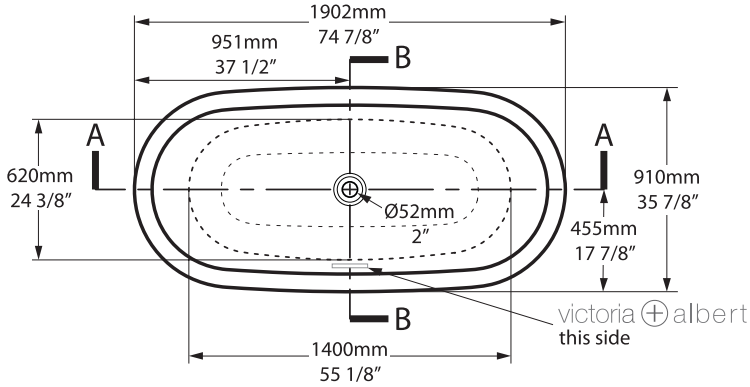

Rim Detail

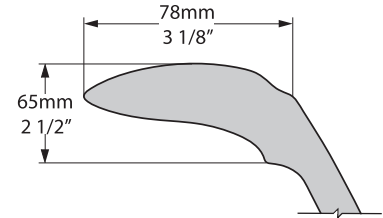

Side view

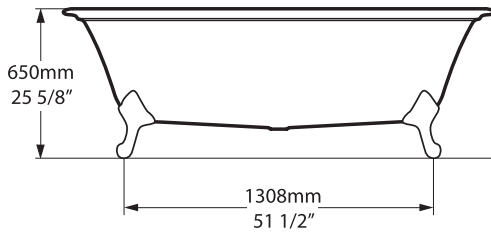

Section BB

Shown with optional K50 waste kit

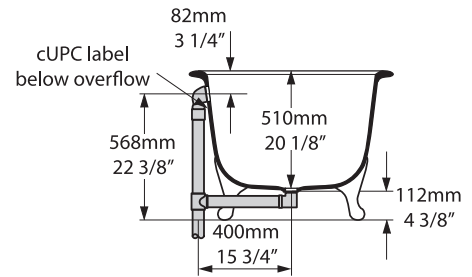

Front view

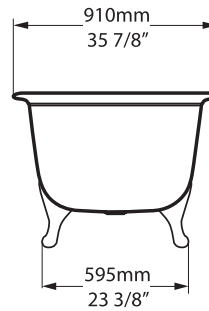

Section AA

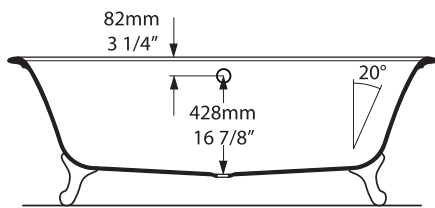

*All measurements subject to +/-5% tolerance

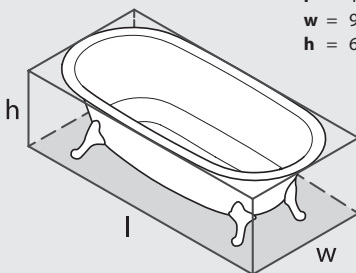

l = 1902mm / 74 7/8"
w = 910mm / 35 7/8"
h = 650mm / 25 5/8"

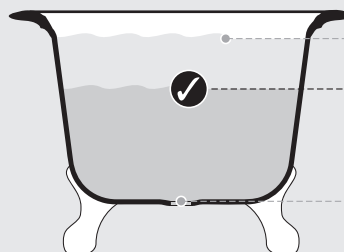

.dwg | .dxf | .skp www.vandabaths.com



Massachusetts Code: Approved
cUPC listing by IAPMO: File No. 6574
Registered Design



VA/1204/06/Jan19