

45DIA
WASTE
CENTRED

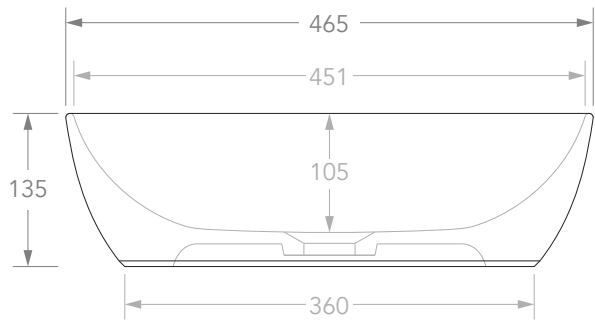

10L CAPACITY
TO RIM

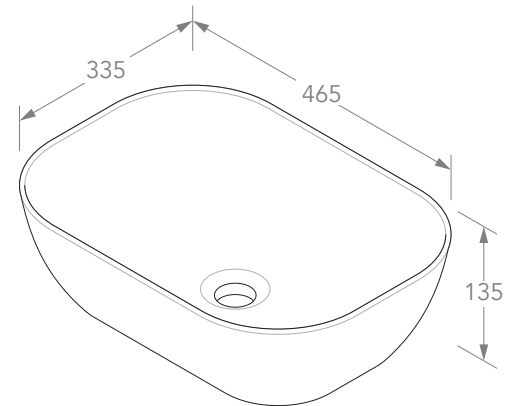
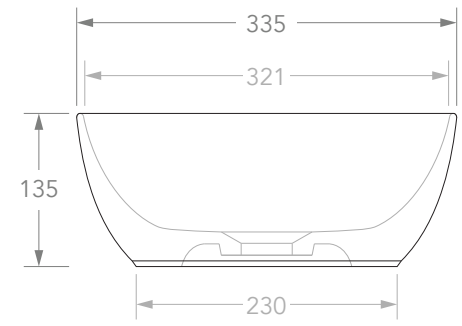

PRODUCT	STADIUM	MATERIAL	CERAMIC	NOTES: DUE TO THE MANUFACTURING NATURE OF CERAMICS, +/-5MM VARIATION IN SIZE AND DETAIL CAN BE EXPECTED. DO NOT DRILL OR ROUGH IN UNTIL YOU HAVE RECEIVED AND MEASURED YOUR PRODUCT. BASIN SUITS 32MM WASTE. ADP UNIVERSAL PLUG AND WASTE RECOMMENDED (SOLD SEPARATELY). BASIN CUTOUT IS A 75 DIAMETER HOLE. ALL DIMENSIONS ARE IN MILLIMETRES. DO NOT MEASURE FROM DRAWING.
CODE	TOPCSTA4632*	*FINISH AND COLOUR	GLOSS WHITE (GW) MATTE BLACK (MB)	
STYLE	ABOVE COUNTER			
DIMENSIONS	465W X 335D X 135H			
CAPACITY	10L TO RIM			
VERSION 1	DATE 23/04/2020			