

DRAFT COPY

DO NOT SCALE. IF IN DOUBT ASK!

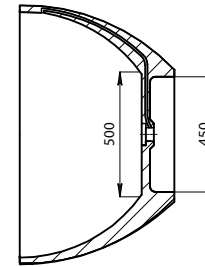

SECTION B-B

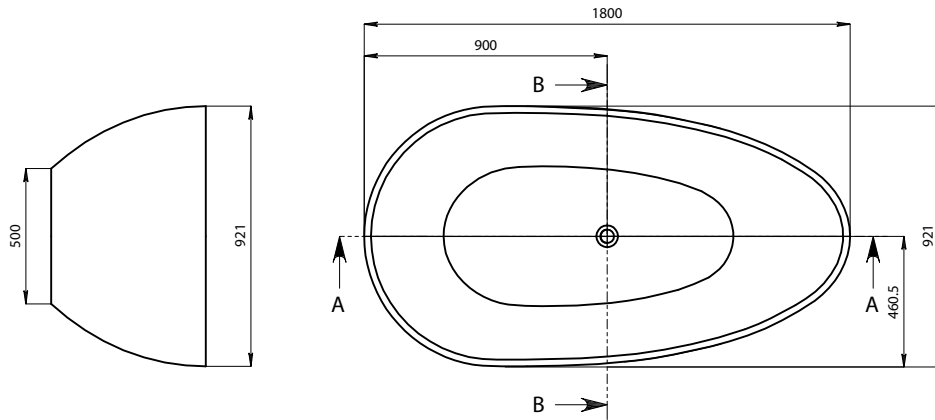
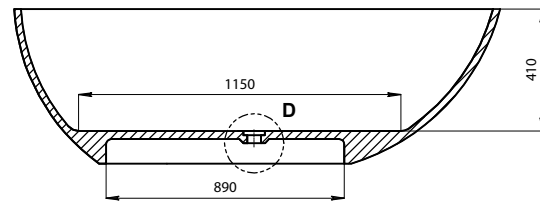
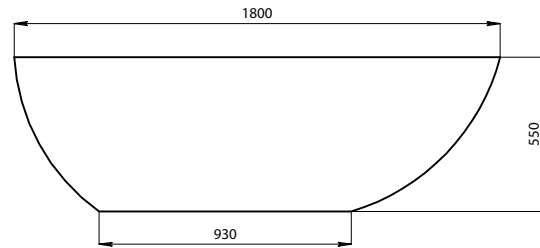
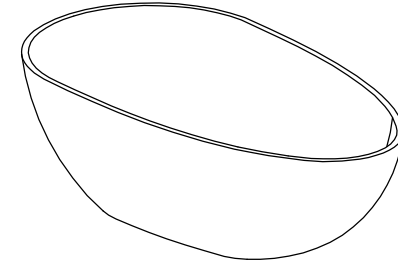

SECTION A-A

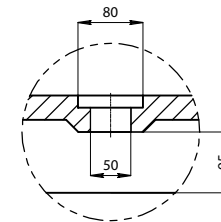

DETAIL D
SCALE 1:4

COLOUR
QTY
APPROVED BY:
NAME & SIGNATURE
DATE APPROVED:

- NOTES
1. ALL INTERNAL CORNERS TO BE R5 UNLESS OTHERWISE STATED.
 2. AS ALL KASKADE PRODUCTS ARE HAND FINISHED A 2-5mm TOLERANCE IS ALLOWED.

COPYRIGHT © APPLIES. DUPLICATION OF THIS DRAWING OR ANY SPECIFIC DESIGN FEATURES IS NOT PERMITTED WITHOUT WRITTEN AUTHORITY. "COMMERCIAL CONFIDENTIALITY" IS ASSUMED AND REQUIRED.

UNLESS OTHERWISE STATED ALL DIMENSIONS IN MILLIMETERS		MATERIAL: KASKADE STONE		DRAWING NUMBER: Viva-RS3-1800		SCALE 1:1	A4
DRAWING LEGEND		FINISH: REFER TO ORDER		Product Size 1800X921X550		SHEET 1 OF 1	REV. 1
N.W. 170 kg		G.W. kg		Package size		 www.kaskadebaths.de	
LINEAR / ANGULAR TOLERANCES		DRAWN: KASKADE		DATE: 02/03/15			
No Decimals 1 Decimal 2 Decimals		CHK'D		DATE			

REV	DESCRIPTION	DWG	DATE	CHK'D	DATE
1	RELEASE DATE.	KASKADE	02/03/15		