







Model Code: LT120BP

Included Accessories

 ICM8	 UMC6	 6020/OFLOW4B
 WKC-B		

Optional Accessories

Dimensions

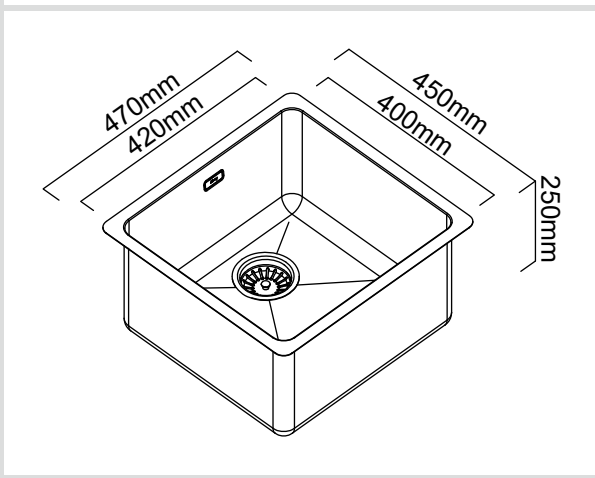

Specifications

Description	Single bowl, Inset/Undermount Sink
Overall Sink Size	470mm x 450mm x 250mm deep
Bowl Dimensions	420mm x 400mm x 250mm deep
Drainer Length	N/A
Technic	Fabrication
Material	Stainless steel SUS304

Installation

Fixings	Inset & Undermount clips supplied
Template	N/A
Min Cabinet Size	500mm
Waste Holes	1 x 90mm round Compatible with waste disposal
Sealing Strip	N/A

Plumbing

Waste Fittings	1 x (90mm x 2") basket waste included
Overflow	Rectangular Overflow

Packaging

Carton Type	Eco packaging & Individual carton
Gross Weight	7Kg
Carton Size	530mm x 350mm x 535mm
Pack QTY	1

SURFACE FINISH



WASTE KIT

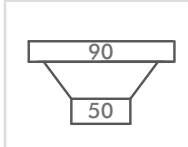

MATERIAL



INSTALLATION OPTIONS

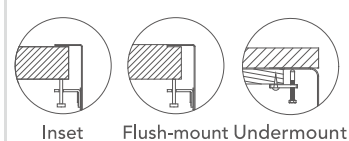

PROFILE

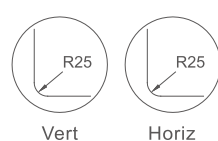

Abey are Australia's leaders in sinkware, designing and manufacturing to the world's highest quality specifications as well as sourcing and bringing you Europe's very best, leading edge designs – practical, affordable, inspirational, stylish, timeless or cutting edge. When you buy an Abey stainless steel sink you receive the highest quality and a 25 year warranty. Abey and the manufacturer are continually seeking ways to improve the design specifications, aesthetic and production techniques of the products. As a result, alterations to the specifications and dimensions of the products and designs occur continually.